

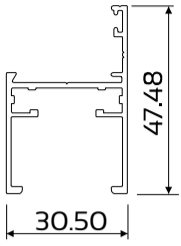

crealco | CASEMENT 30.5

WINDOW (30.5mm)

Profiles



DIE No. W32028A Cas30.5 Frame 30mm Unequal Leg

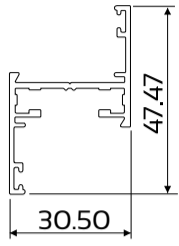

DIE No. W32027 Cas30.5 Frame 30mm Unequal Leg

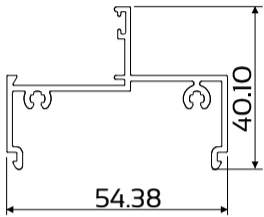

DIE No. W28481 Frame 54mm

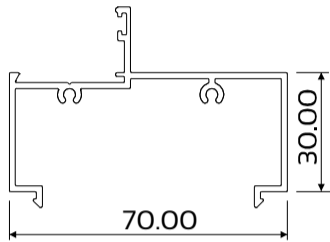

DIE No. W70968 Frame 70mm

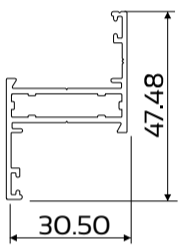

DIE No. W55684A Cas30.5 Sash Tubular

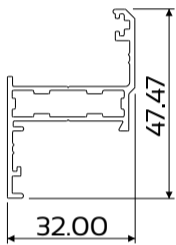

DIE No. W55441 Sash Picture Frame

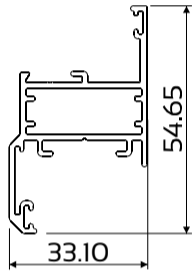

DIE No. W57602 Cas 30.5 Sash Euro

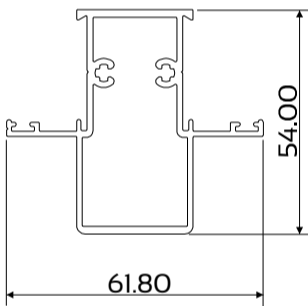

DIE No. W54651A Cas30.5 Mullion 54mm

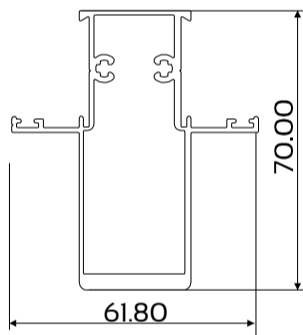

DIE No. W54652A Cas30.5 Mullion 70mm

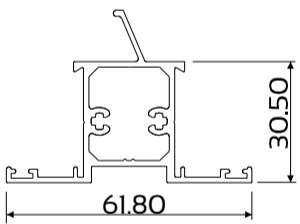

DIE No. W53630 Cas30.5 Mullion 30mm Weather Bar

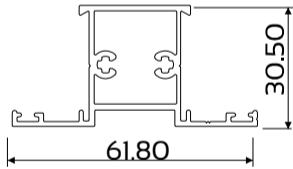

DIE No. W55685A Cas30.5 Mullion 30mm Standard

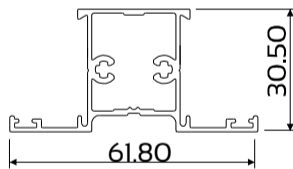

DIE No. W55008 Cas30.5 Mullion 30mm Econo

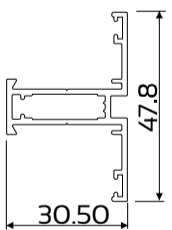

DIE No. W54867 Cas30.5 30mm Cottage Pane Mullion

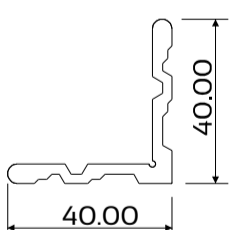

DIE No. W27989 Cas30.5 Corner Cleat 40mm

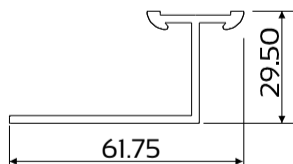

DIE No. W28002 Cas30.5 Fixing Lug Twist In

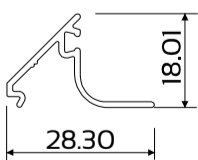

DIE No. W31139A Cas30.5 Bead Multi 13mm Gap

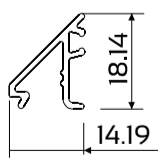

DIE No. W35620 Cas30.5 Bead Euro 13mm Gap

Elevations & Sections

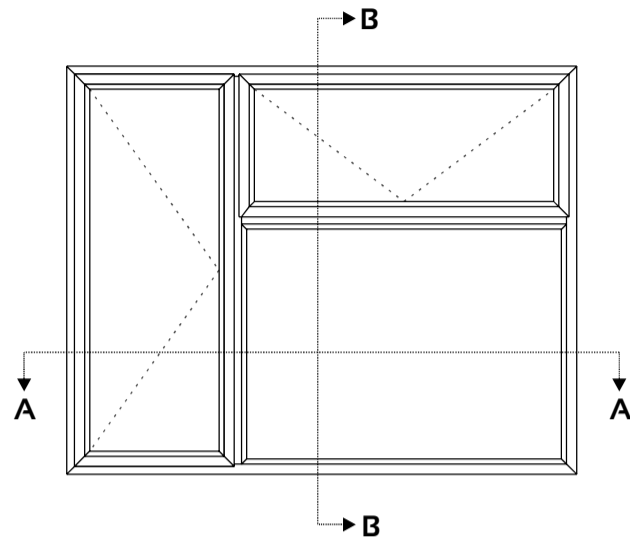

Maximum Sash Sizes (WxH) to suit Friction Stay		
Standard Sash	Top Hung	1200 x 900
	Side Hung	700 x 1500
Euro Sash	Top Hung	1200 x 1200
	Side Hung	700 x 1200
Double Glazing	Top Hung	1000 x 750
	Side Hung	600 x 700

SECTION B-B
Section not to scale

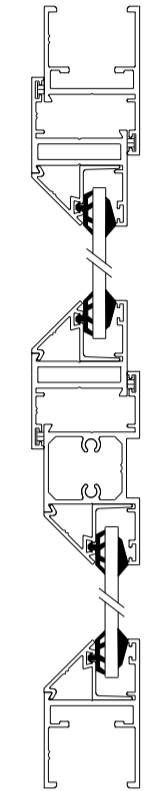

SECTION A-A
Section not to scale

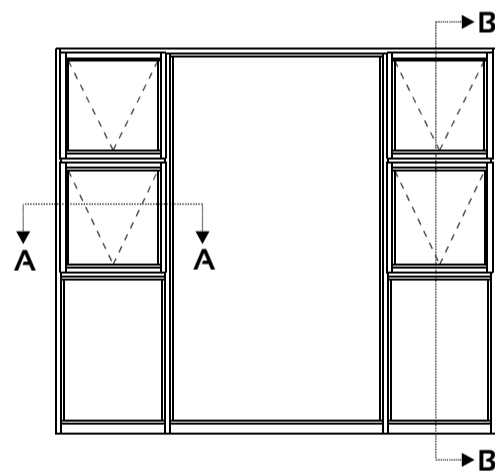
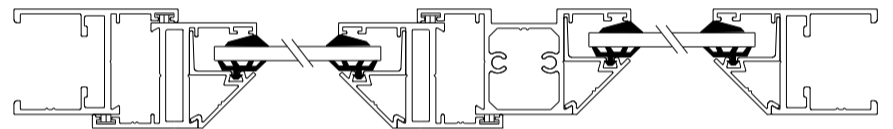

SECTION B-B
Section not to scale

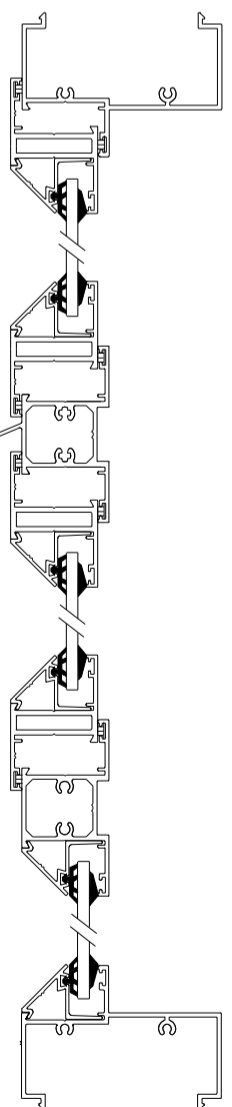

SECTION A-A
Section not to scale

